

HAEGER® Part Number	
Anvil	H-186-8/M4L
Punch	H-185-8/M4L

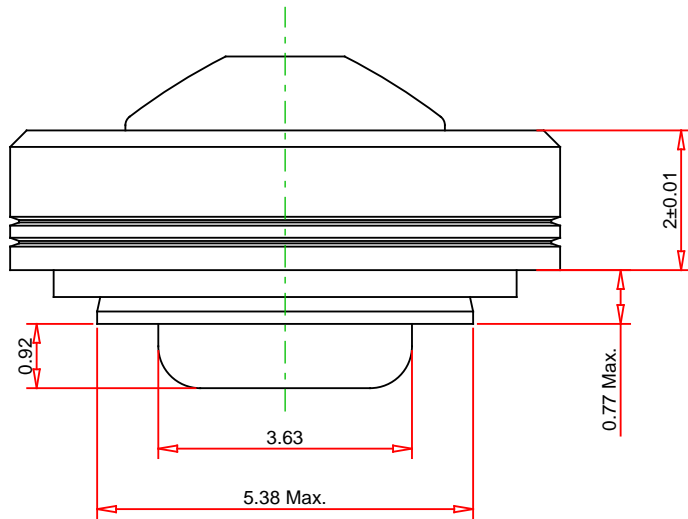

© 2024 PennEngineering

ALL DIMENSIONS IN MILLIMETERS

DATE 16-APR-2024

NOTE : DRAWING NOT TO SCALE

THREAD : M4 x 0.7	MOUNTING HOLE DIA. : 5.41 +0.08 -0.00
MATERIAL: 300 Series Stainless Steel	PANEL THICKNESS: 0.8 MINIMUM
HEAT TREAT: NONE	MAX. PANEL HARDNESS: HRB 70 / HB 125
FINISH: Passivated and/or tested per ASTM A380	MIN CENTERLINE-TO-EDGE: 6.9

DESCRIPTION :  
PEM® PreTect™ Thread Masking Plugs



PennEngineering®

PART NO. :  
CLS-M4-0-TP

EMAIL: TECHSUPPORT@PEMNET.COM  
WWW.PEMNET.COM